

Compact size,
quiet blowing

Energy-efficient air nozzles

TAIFUJet®

Stainless steel

Reduce air consumption
by the uniform, **high impact**
air jet



Also available in heat-
and chemical-resistant PPS



Features

- Pressure-resistant stainless steel air nozzle.
- The 35 mm-long compact body provides a powerful air blow with high blowing force and optimal energy saving.
It helps further reductions in equipment size and costs.
- Low-noise design for a better work environment.

Sound level

Orifice diameter	Air pressure (MPa)	Noise level (dBA)
ø0.8	0.1	62
	0.3	73
	0.5	79
ø1.0	0.1	68
	0.3	78
	0.5	84
ø1.2	0.1	72
	0.3	82
	0.5	88

Ground noise: 46 dBA,
Distance from noise meter: 1,000 mm

Specifications

Material: Stainless steel 316L equivalent
 Mass: 38 g
 Max. operating pressure: 1.0 MPa
 Max. allowable temperature: 400°C

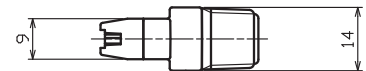
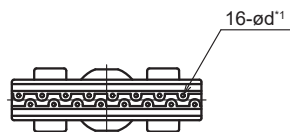
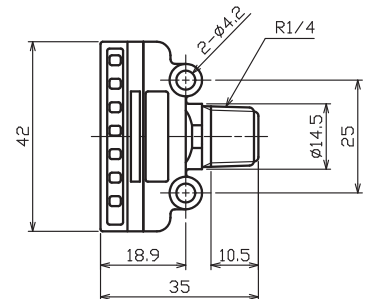

*1) ød = Orifice diameter 0.8, 1.0, or 1.2 mm

Air consumption

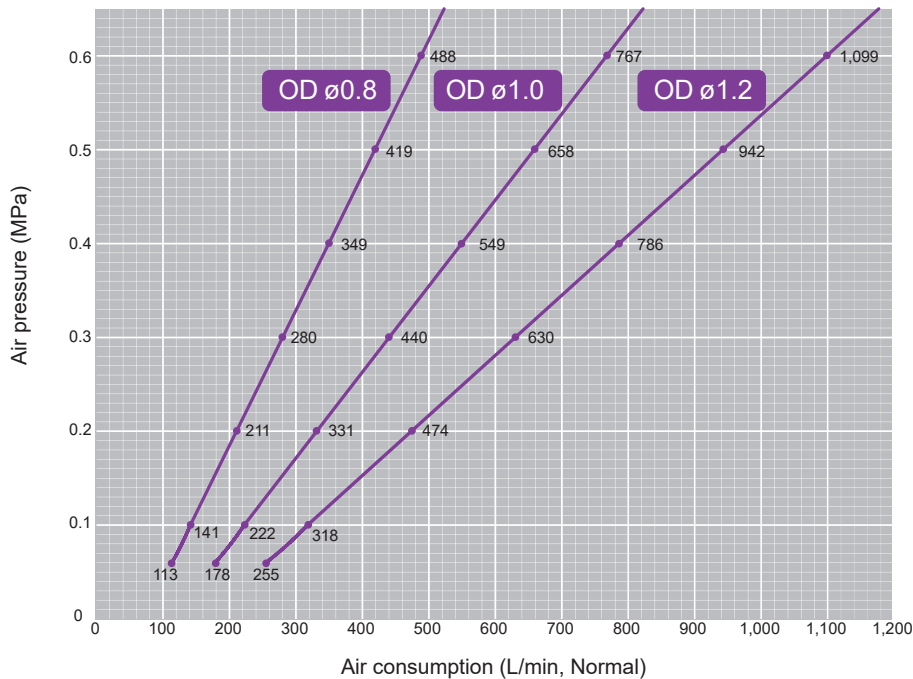

OD =
Orifice Diameter

Blowing force distribution

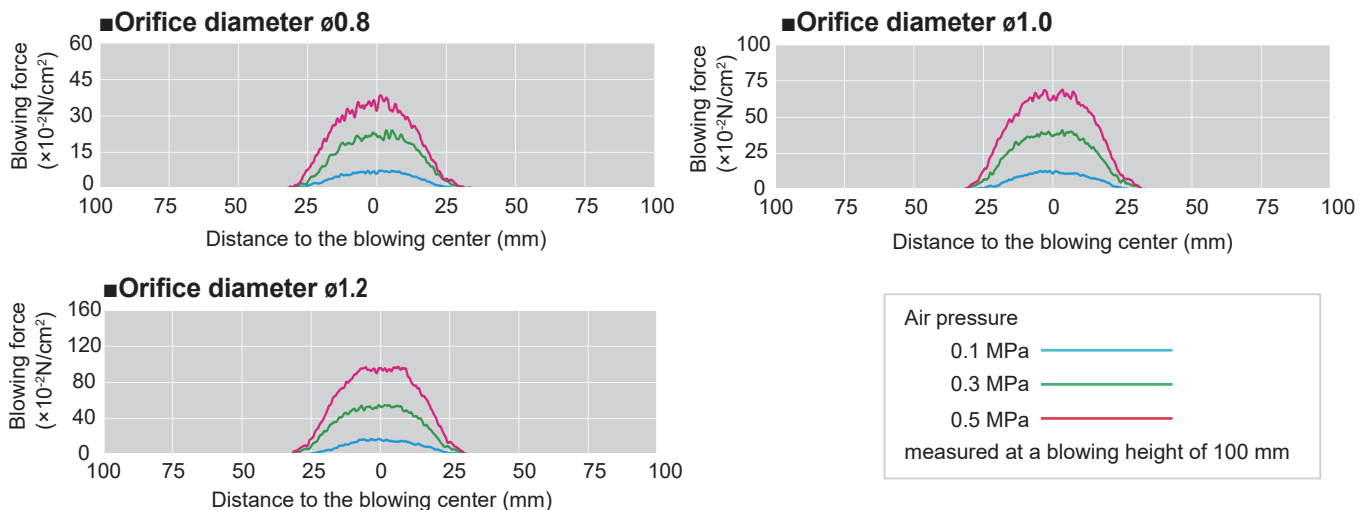

1/4M (PT) TF-FS 42-16-010

Pipe conn. size² Thread type

■PT
■NPT

²) "M" indicates male thread ("R" of the ISO standard), e.g. 1/4M = R1/4.

S316L-IN

Material

Orifice diameter code

■008 (ø0.8)
■010 (ø1.0)
■012 (ø1.2)

Specifications and contents of this leaflet are subject to change without prior notice for purpose of product improvement.

Please feel free to send any inquiry, request for information or quote on this product to the contacts below.



"The Fog Engineers"
H. IKEUCHI & CO., LTD.

Headquarters

Daiichi Kyogyo Bldg., 1-15-15, Awaza, Nishi-ku, Osaka 550-0011, Japan
Tel: 81-6-6538-4015 Fax: 81-6-6538-4022
E-mail: overseas@kirinoikeuchi.co.jp
URL: <https://www.kirinoikeuchi.co.jp/eng/>

We have our branches and affiliate companies around the world—in China, USA, The Netherlands, Thailand, Indonesia, UAE, and more.
Please see our website for the nearest contact.

<https://www.kirinoikeuchi.co.jp/eng/company/location/>

**42 mm wide
Short type
Air nozzle**

Multiplies Supplied Air

Air Booster Nozzle *TAIFUJet*® **TF-FS** series

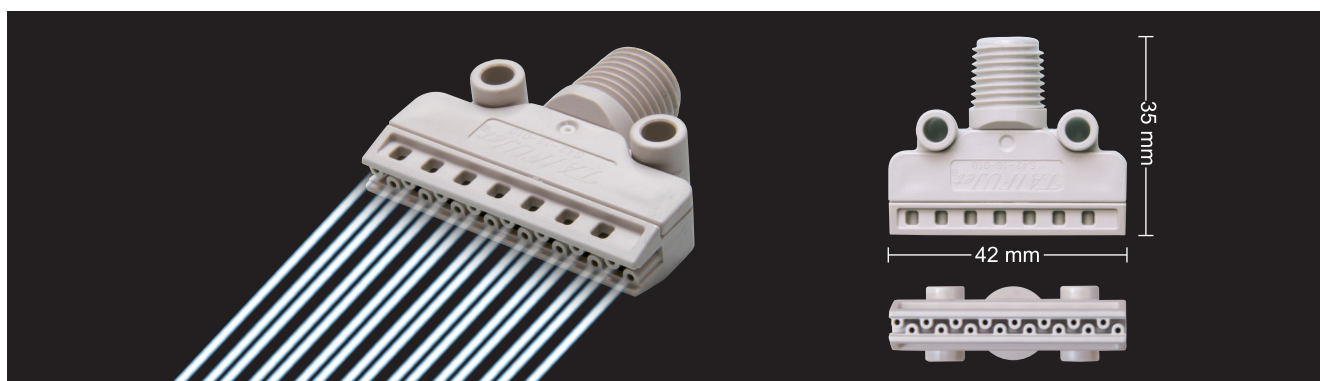

Features

- Compact air nozzle: 35 mm long, 42 mm wide
- Low noise, minimal air consumption
- Uniform distribution and high spray impact
- Made of high chemical and heat resistant PPS

Dimensions, Material, Mass

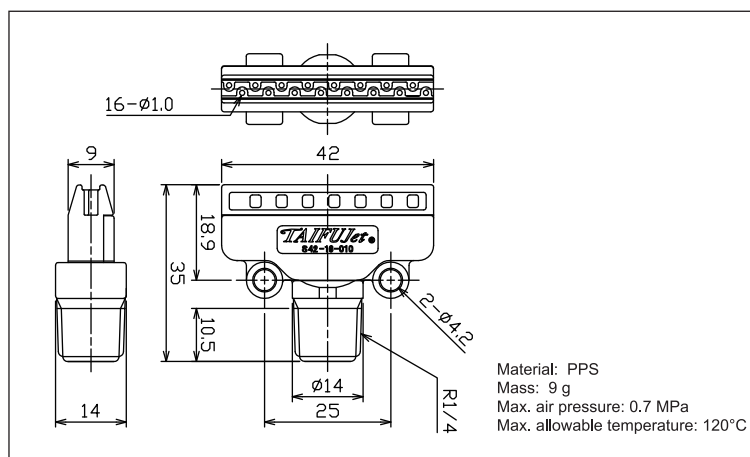

Air flow rate

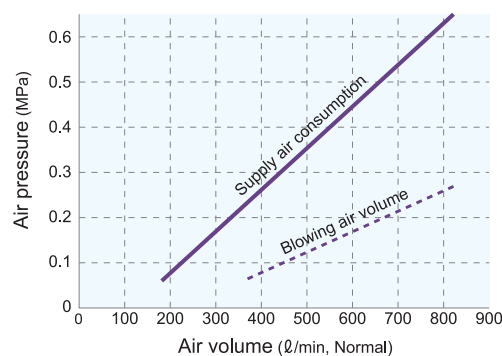

How to order Please inquire or order using this product code.

1/4M TF-FS 42-16-010 PPS

Specifications of the product and contents of this leaflet are subject to change without prior notice for purpose of product improvement.

Please feel free to send any inquiry, request for information or quote on this product to the contacts below.

 "The Fog Engineers"
H. IKEUCHI & CO., LTD.

Headquarters Tel: 81-6-6538-4015
Fax: 81-6-6538-4022

Daiichi Kyogyo Bldg., 1-15-15, Awaza
Nishi-ku, Osaka 550-0011, Japan
E-mail: overseas@kirinoikeuchi.co.jp
URL: <https://www.kirinoikeuchi.co.jp/eng/>

IKEUCHI (SHANGHAI) CO., LTD.

Tel: 86-21-6140-9731 Fax: 86-21-6123-4239
mist@kirinoikeuchi.com <http://www.kirinoikeuchi.com/>

Tianjin Branch Tel: 86-22-2320-1676
Fax: 86-22-2320-1675

Shenzhen Branch Tel: 86-755-8525-2221
Fax: 86-755-8525-2215

IKEUCHI USA, INC.

Tel: 1-513-942-3060 Fax: 1-513-942-3064
info@ikeuchiusa.com <https://www.ikeuchi.us/>

Georgia Office Tel: 1-706-850-3332 Fax: 1-706-850-3309

IKEUCHI EUROPE B.V.

Tel: 31-20-820-2175 Fax: 31-20-820-2176
info@ikeuchieurope.com <http://www.ikeuchieurope.com/>

IKEUCHI TAIWAN CO., LTD.

Tel: 886-2-2511-6289 Fax: 886-2-2541-6392
sales@ikeuchi.com.tw <http://www.ikeuchi.com.tw/>

PT. IKEUCHI INDONESIA

Tel: 62-21-2909-3246 Fax: 62-21-2909-3247
sales@ikeuchi.co.id <https://www.ikeuchi.id/>